

X-Protect

Double impact low

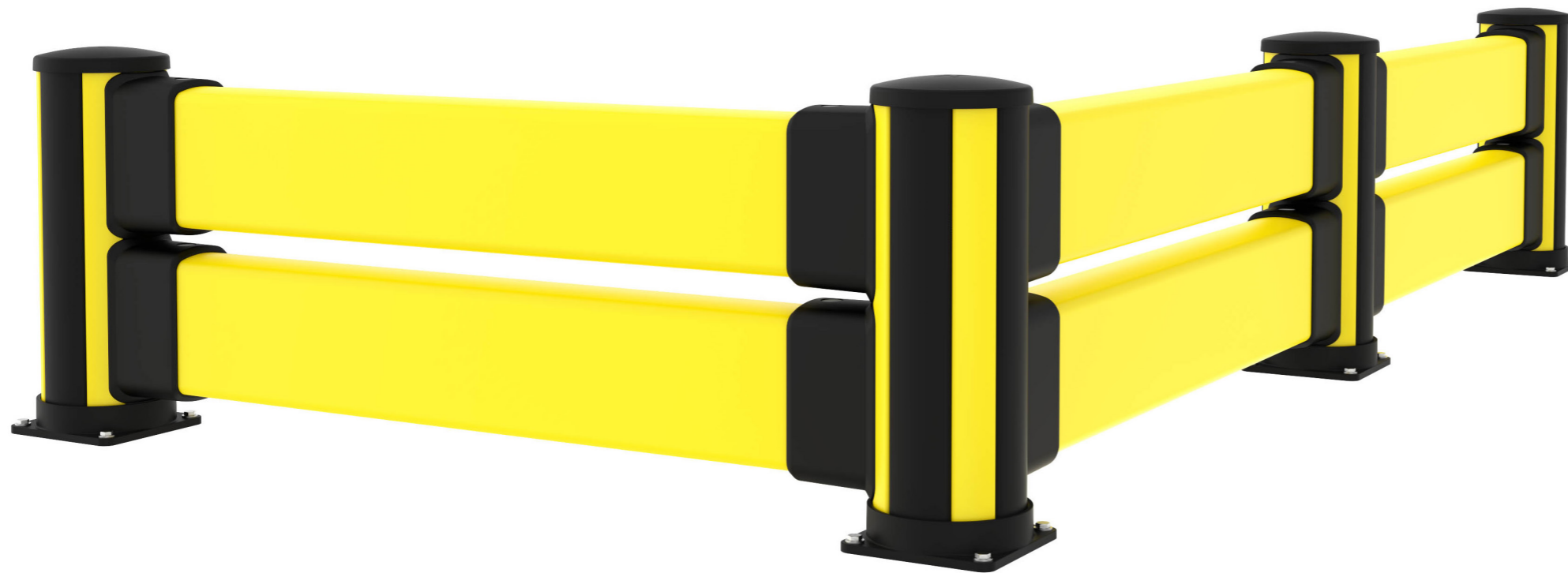

AXELENT AB
WWW.AXELENT.COM

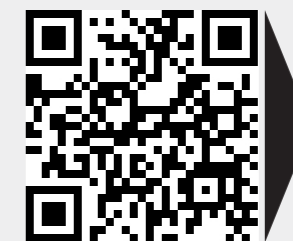

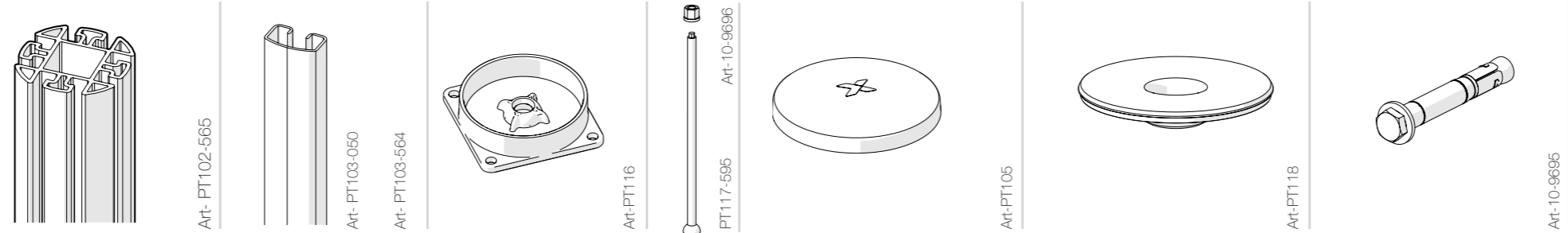

BCE0-061-I200
BCM0-061-I200
BCC0-061-I200

1	1	3	1	1+1	1	1	4
1	2	2	1	1+1	1	1	4
1	2	2	1	1+1	1	1	4

CCS9-000-I100

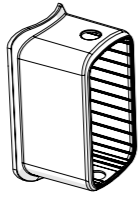
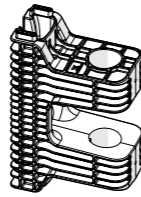
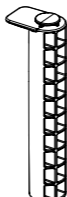
	Art-PT108		Art-PT109		Art-PT111
2		2		2	
4		4		4	
4		4		4	

BCE0-061-I200
BCM0-061-I200
BCC0-061-I200

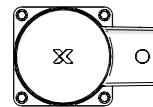



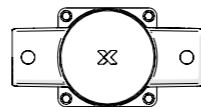



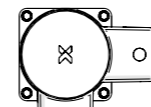





BCE0-061-I200



BCM0-061-I200



BCC0-061-I200

											
PT103-564	CCS9-000-I100	PT103-564	PT103-564	PT103-564	CCS9-000-I100	PT103-564	CCS9-000-I100	PT103-564	CCS9-000-I100	CCS9-000-I100	PT103-564
	CCS9-000-I100				CCS9-000-I100		CCS9-000-I100		PT103-050	PT103-050	
	PT103-050				PT103-050		PT103-050				

RCI1-XXX-XXXX
 ECI1-length-centre to centre)



The pin hole location, size and adjacent material integrity are critical to the overall system function and performance. Axelent therefore advises against any onsite alterations as performance cannot be guaranteed.

