

X-Protect

Pedestrian + Impact high

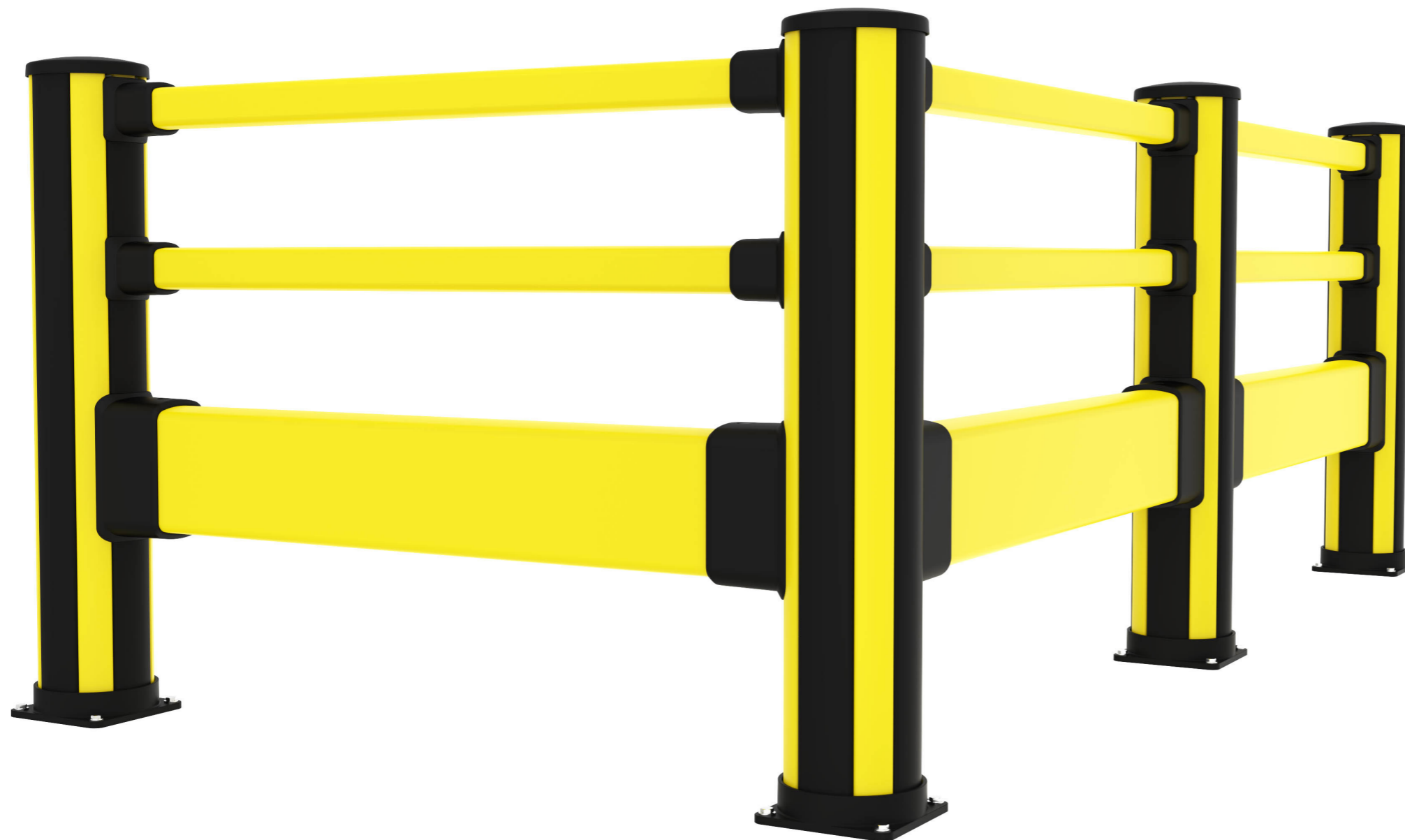

AXELENT AB

WWW.AXELENT.COM



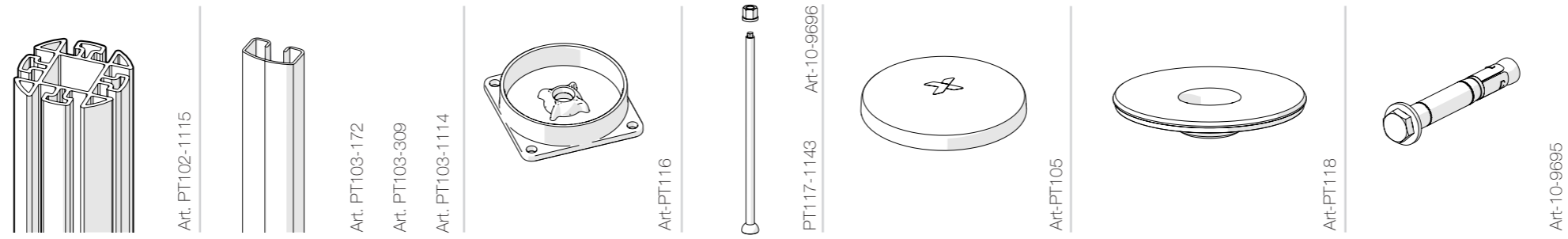

BCE0-116-I1P2
BCM0-116-I1P2
BCC0-116-I1P2

1		2	1	3	1	1+1	1	1	4
1		4	2	2	1	1+1	1	1	4
1		4	2	2	1	1+1	1	1	4

CCS9-000-00P1

Art. PT106	Art. PT107	Art. PT110
2	2	2
4	4	4
4	4	4

CCS9-000-I100

Art. PT108	Art. PT109	Art. PT111
1	1	1
2	2	2
2	2	2

BCE0-116-I1P2
BCM0-116-I1P2
BCC0-116-I1P2

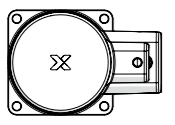

BCE0-116-I1P2

	CCS9-000-00P1			
	PT103-172			
	CCS9-000-00P1			
PT103-1114	PT103-172	PT103-1114	PT103-1114	
	CCS9-000-I100			
	PT103-309			

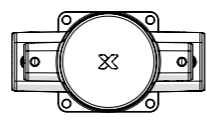

BCM0-116-I1P2

	CCS9-000-00P1		CCS9-000-00P1	
	PT103-172		PT103-172	
	CCS9-000-00P1		CCS9-000-00P1	
PT103-1114	PT103-172	PT103-1114	PT103-172	
	CCS9-000-I100		CCS9-000-I100	
	PT103-309		PT103-309	

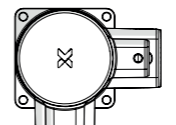

BCC0-116-I1P2

			CCS9-000-00P1	CCS9-000-00P1
			PT103-172	PT103-172
			CCS9-000-00P1	CCS9-000-00P1
PT103-1114	PT103-1114	PT103-172	PT103-172	
		CCS9-000-I100	CCS9-000-I100	
		PT103-309	PT103-309	

RCP1-XXX-XXXX
 (RC1-length-centre to centre)

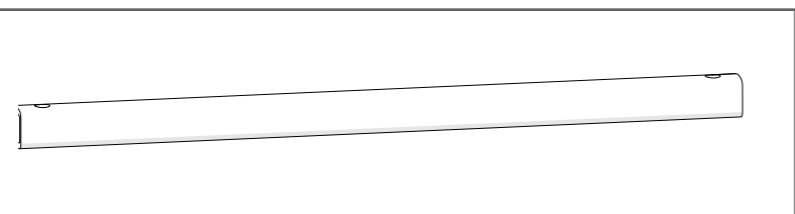

RCI1-XXX-XXXX
 (RC1-length-centre to centre)

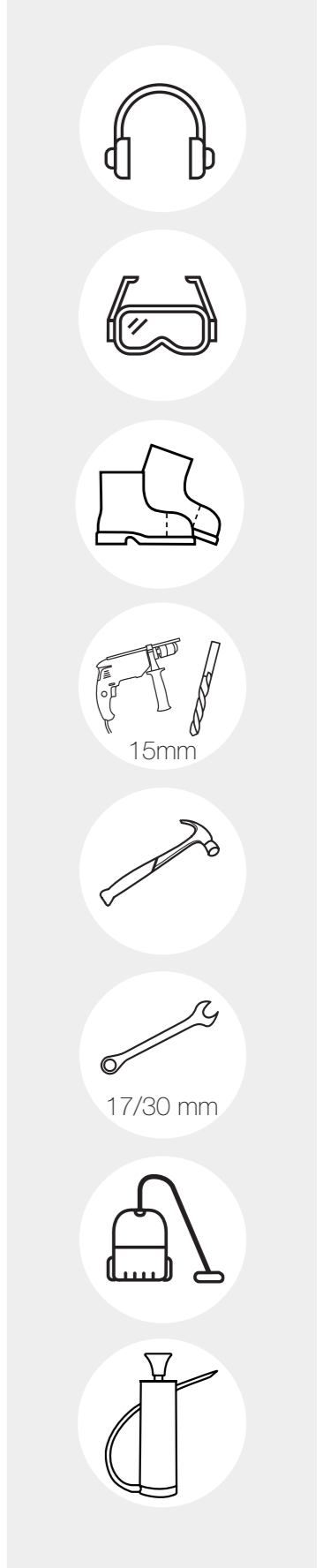

The pin hole location, size and adjacent material integrity are critical to the overall system function and performance. Axelent therefore advises against any onsite alterations as performance cannot be guaranteed.

