

# X-Protect

Pedestrian

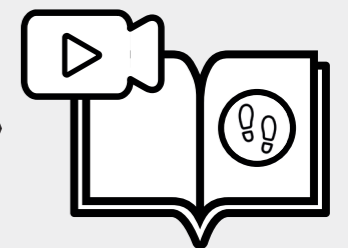
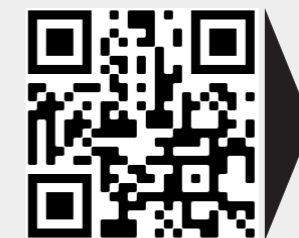
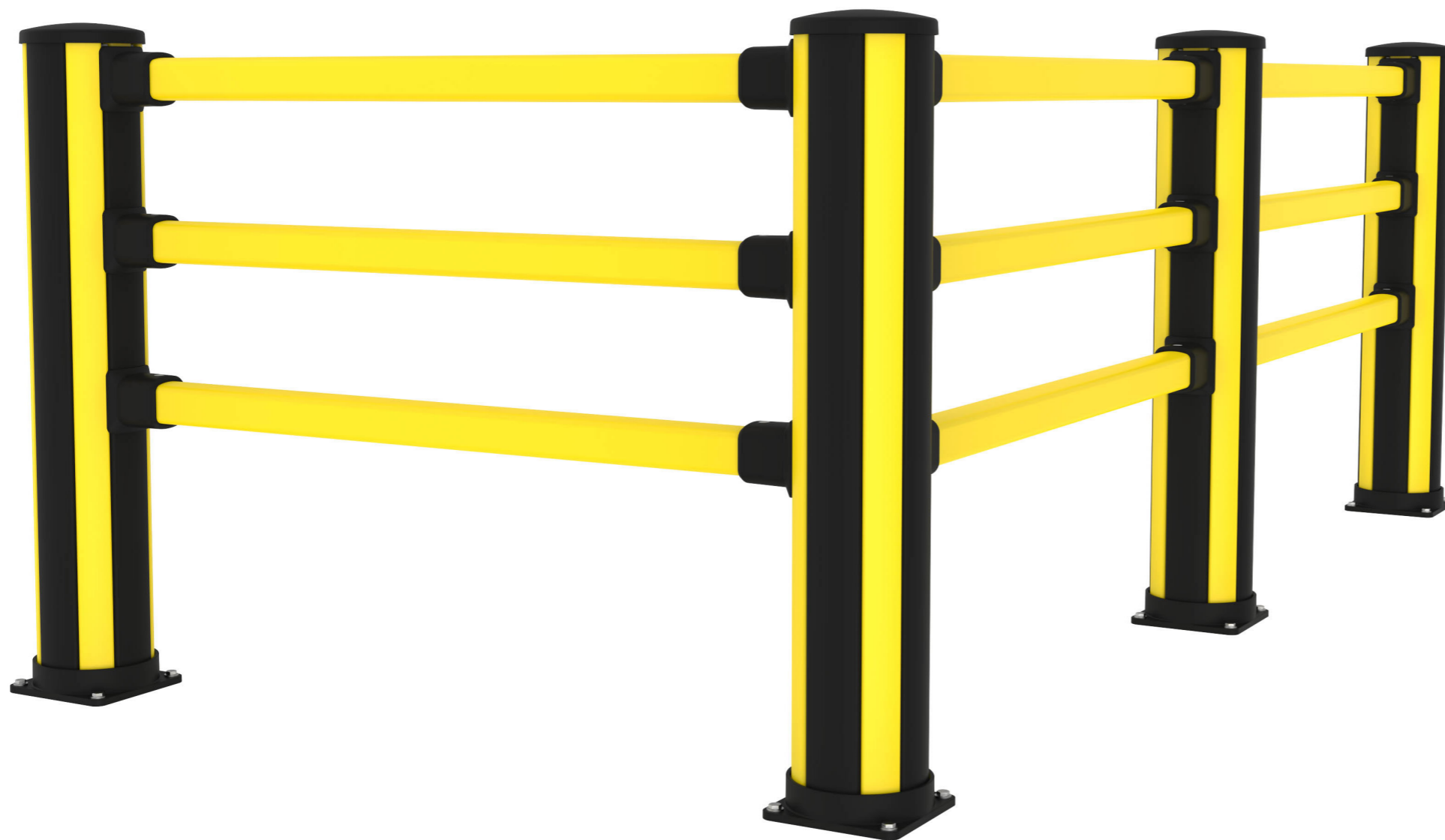

**AXELENT AB**

[WWW.AXELENT.COM](http://WWW.AXELENT.COM)



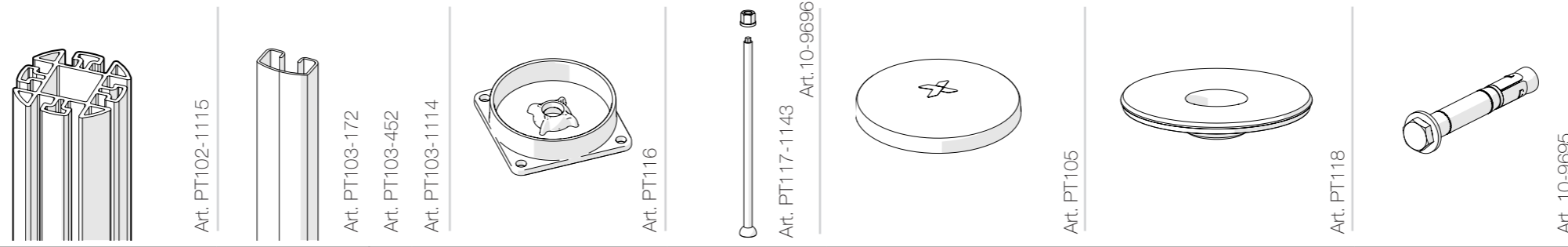

**BCE1-116-00P3**  
**BCM1-116-00P3**  
**BCC1-116-00P3**

1	3	1	2	1	1+1	1	1	4
1	2	4	2	1	1+1	1	1	4
1	2	4	2	1	1+1	1	1	4

**CCS9-000-00P1**

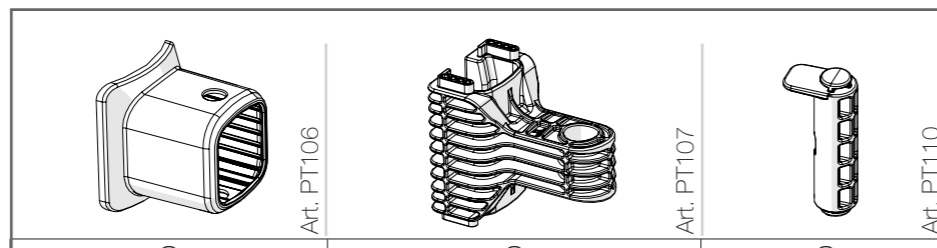

**BCE1-116-00P3**  
**BCM1-116-00P3**  
**BCC1-116-00P3**

3	3	3
6	6	6
6	6	6

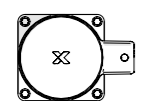

**BCE1-116-00P3**

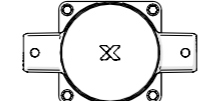

**BCM1-116-00P3**

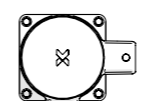

**BCC1-116-00P3**

	CCS9-000-00P1		
	PT103-172		
	CCS9-000-00P1		
PT103-1114	PT103-172	PT103-1114	PT103-1114
	CCS9-000-00P1		
	PT103-452		

	CCS9-000-00P1		CCS9-000-00P1
	PT103-172		PT103-172
	CCS9-000-00P1		CCS9-000-00P1
PT103-1114	PT103-172	PT103-1114	PT103-172
	CCS9-000-00P1		CCS9-000-00P1
	PT103-452		PT103-452

			CCS9-000-00P1
			CCS9-000-00P1
PT103-1114	PT103-1114	PT103-172	PT103-172
		CCS9-000-00P1	CCS9-000-00P1
		PT103-452	PT103-452

**RCP1-XXX-XXXX**  
 (RCP1-length-centre to centre)



*The pin hole location, size and adjacent material integrity are critical to the overall system function and performance. Axelent therefore advises against any onsite alterations as performance cannot be guaranteed.*

