

# P11-230-A01

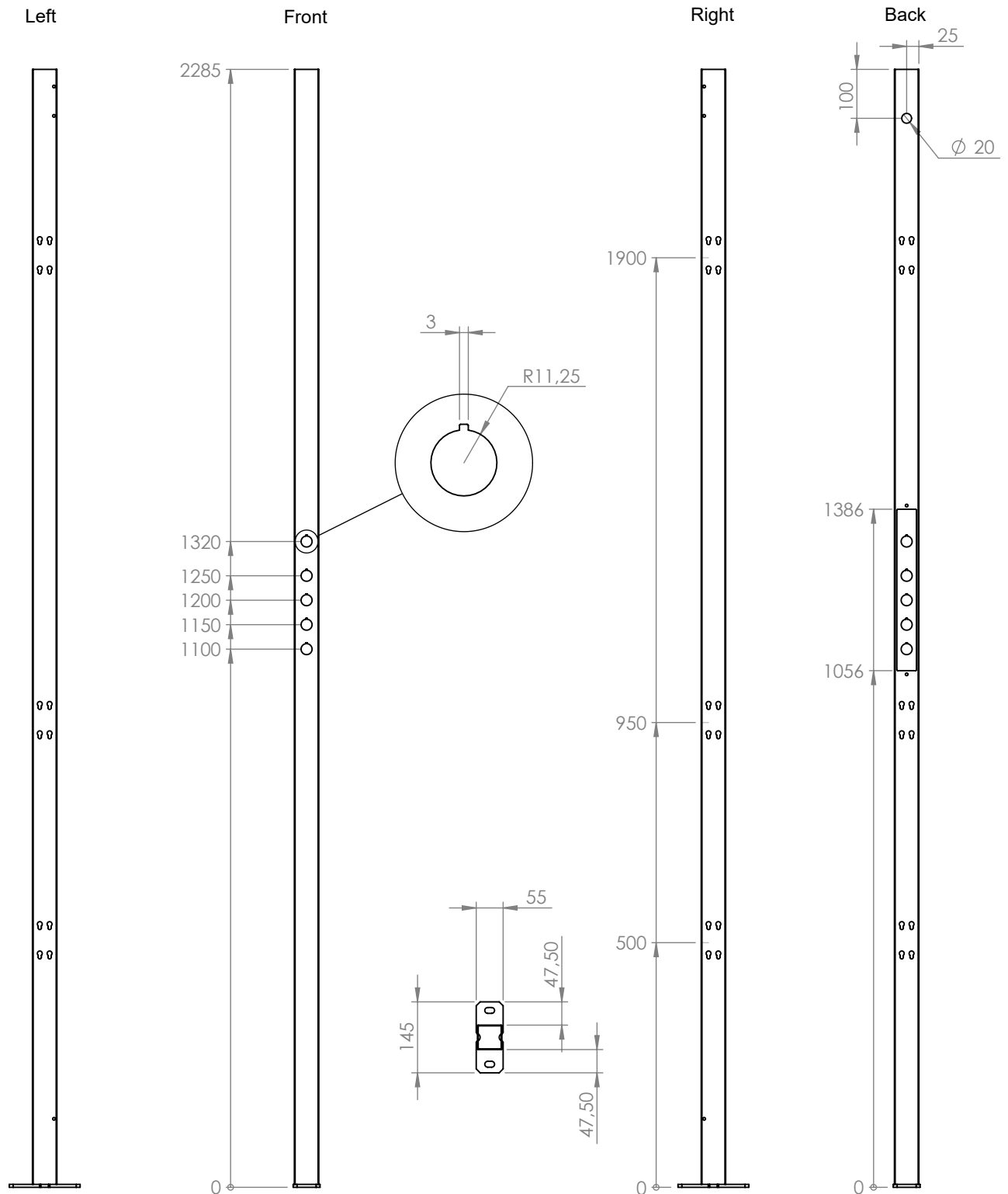

Axelent AB	BOX 1 · KÄVSJÖVÄGEN 17 SE-335 04 · HILLERSTORP SWEDEN	INFO@AXELENT.SE AXELENT.COM	Date: 2019-08-15 TEL +46 (0)370-37 37 30
C-number (for internal use) C-0003735-01	Drawing-ID 01-230-A01-KR	Part/Assembly/Config ID (for internal use) Default(A-0001510)	Description / Article number Post with foot prepared for push buttons, 50x50, H=2300 mm
			Weight (calc.) 5189 g
			Version A